



7506024150958

### REPUESTO PARA SOPORTE DE MOTOR DERECHO SUPERIOR (7409)

MARCA	MODELO		
NISSAN	ROGUE	L4 2.5	08-14
NISSAN	SENTRA	L4 2.5	07-13
NISSAN	X-TRAIL	L4 2.5	08-14
RENAULT	KOLEOS	L4 2.5	08-16



## 7409-9



7506024150941

### REPUESTO PARA SOPORTE DE MOTOR DERECHO SUPERIOR (7546)

MARCA	MODELO		
NISSAN	JUKE	L4 1.6	11-18
NISSAN	SENTRA	L4 1.8	13-16
NISSAN	SENTRA	L4 1.6	2017

OEM N-D



## 7546-9



7506024150965

### REPUESTO PARA SOPORTE DE TRANSMISIÓN (7822)

MARCA	MODELO		
MAZDA	3	L4 2.0	14-16
MAZDA	3	L4 2.5	14-16
MAZDA	6	L4 2.5	13-17
MAZDA	CX-5	L4 2.0	13-16
MAZDA	CX-5	L4 2.5	14-19



## 7822-9





7506024150927

### REPUESTO PARA SOPORTE DE TRANSMISIÓN (7938)

MARCA	MODELO		
DODGE	ATTITUDE	L3 1.2	14-15
MITSUBISHI	MIRAGE	L3 1.2	14-18



## 7938-9



7506024145510

### SOPORTE PARA MOTOR FRONTAL IZQUIERDO

MARCA	MODELO		
CHEVROLET	MALIBU	L4 2.2	97-99
CHEVROLET	MALIBU	L4 2.4	97-99
CHEVROLET	MALIBU	V6 3.1	97-03
OLDSMOBILE	ALERO	L4 2.4	99-01
OLDSMOBILE	ALERO	V6 3.4	99-04
OLDSMOBILE	CUTLASS NA.	V6 3.1	97-99
PONTIAC	GRAND AM	L4 2.4	99-01
PONTIAC	GRAND AM	V6 3.4	99-05



## 8081



OEM 22605204



7506024146609

### SOPORTE PARA MOTOR IZQUIERDO

MARCA	MODELO		
DODGE	NITRO	V6 4.0	07-11

OEM 52125107/AD



## 8150





7506024146616

### SOPORTE PARA TRANSMISIÓN

MARCA	MODELO		
AUDI	A4	L4 2.0	11-16
AUDI	A5	L4 2.0	10-14
AUDI	A6	L4 2.0	12-15
AUDI	A7	V6 3.0	14-15
AUDI	Q5	V6 3.0	13-17
AUDI	Q5	V6 3.2	09-12
PORSCHE	MACAN	L4 2.0	2019
PORSCHE	MACAN	V6 3.0	15-19
PORSCHE	MACAN	V6 3.6	15-18

OEM 8K0-399-151-DB

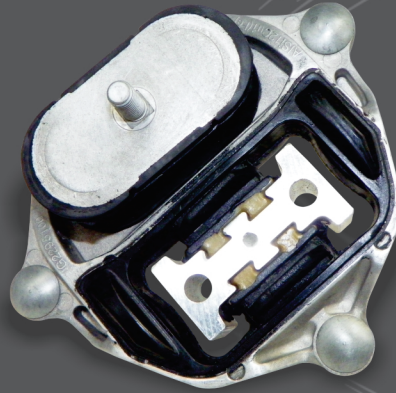

# 8151



7506024146623

### SOPORTE PARA TRANSMISIÓN

MARCA	MODELO		
AUDI	A4	L4 2.0	09-16
AUDI	A4	V6 3.6	2009
AUDI	A5	L4 2.0	10-17

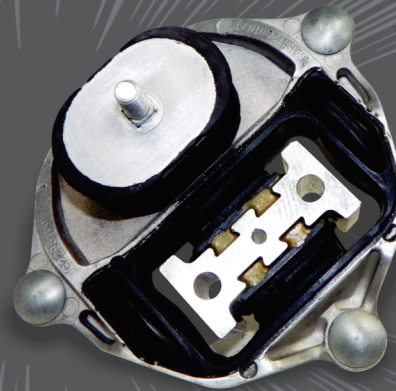

# 8152



OEM 8K0-399-151-BD



7506024150736

### BASE PARA AMORTIGUADOR FRONTAL

MARCA	MODELO	 15
AUDI	A3	04-12
AUDI	TT	07-14
SEAT	ALTEA	06-15
SEAT	LEON	13-16
SEAT	TOLEDO	06-12
VW	BORA	06-10
VW	CC	08-15
VW	GOLF V	06-09
VW	GOLF VI	10-12
VW	JETTA V	06-10
VW	JETTA VI	10-14
VW	PASSAT	05-19
VW	TIGUAN	09-17



OEM 1K0-412-331-B, 1KD-412-331-A

# 8154



7506024146647

### BASE PARA AMORTIGUADOR FRONTAL

MARCA	MODELO	 15
AUDI	A3	04-12
AUDI	TT	07-14
SEAT	ALTEA	06-15
SEAT	LEON	13-16
SEAT	TOLEDO	06-12
VW	BORA	06-10
VW	CC	08-15
VW	GOLF V	06-09
VW	GOLF VI	10-12
VW	JETTA V	06-10
VW	JETTA VI	10-14
VW	PASSAT	05-19
VW	TIGUAN	09-17



OEM 1K0-412-331-B, 1KD-412-331-A  
1K0-412-249-B

# 8154-KIT



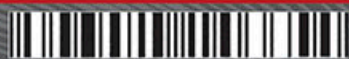

7506024146654

### SOPORTE PARA MOTOR DERECHO FRONTAL INFERIOR

MARCA	MODELO		
CHEVROLET	CHEVY	L4 1.4	93-98
CHEVROLET	CHEVY	L4 1.6	93-98

OEM 90250348



## 8155



7506024146661

### SOPORTE PARA MOTOR TRASERO TRANSMISIÓN AUT.

MARCA	MODELO		
HYUNDAI	ELANTRA	L4 2.0	07-12

OEM 21930-2H050



## 8156



7506024146678

### SOPORTE PARA MOTOR DERECHO

MARCA	MODELO		
TOYOTA	AVANZA	L4 1.5	06-16

OEM 12361-BZ030

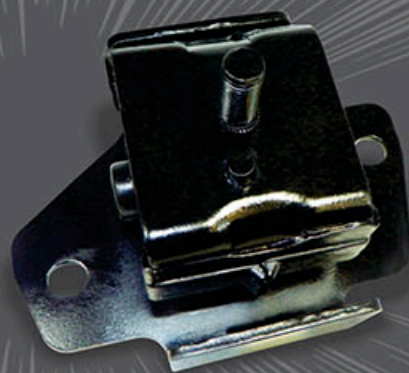

## 8157





7506024146791

### SOPORTE PARA MOTOR FRONTAL

MARCA	MODELO		
HYUNDAI	SANTA FE	L4 2.4	01-04
HYUNDAI	SANTA FE	V6 2.7	01-06

OEM 21910-26200



## 8167

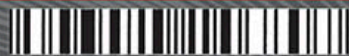

7506024146807

### SOPORTE PARA MOTOR FRONTAL

MARCA	MODELO		
KIA	SPECTRA	L4 2.0	04-09

OEM 21910-2F010



## 8168



7506024150743

### SOPORTE PARA MOTOR IZQUIERDO STD.

MARCA	MODELO		
HONDA	CR-V	L4 2.0	97-01

OEM 50828-S77-003



## 8182-H





7506024150767

### SOPORTE PARA MOTOR FRONTAL IZQUIERDO

MARCA	MODELO		
CHEVROLET	MALIBU CLASIC	L4 2.2	04-05
OLDSMOBILE	ALERO	L4 2.2	02-04
PONTIAC	GRAND AM	L4 2.2	02-05

OEM 22621543



## 8183



7506024145749

### SOPORTE PARA MOTOR DERECHO

MARCA	MODELO		
AUDI	A4	L4 1.8	97-01
AUDI	A4 QUATTRO	L4 1.8	97-01
VW	PASSAT	L4 1.8	98-05
VW	PASSAT	L4 1.9	1998

OEM 8D0-199-379-AQ



## 8184-H



7506024150781

### SOPORTE PARA MOTOR IZQUIERDO Y DERECHO

MARCA	MODELO		
CHEVROLET	EQUINOX	V6 3.6	08-09
PONTIAC	TORRENT	V6 3.6	08-09
SUZUKI	XL-7	V6 3.6	07-09

OEM 25805303  
1165078501

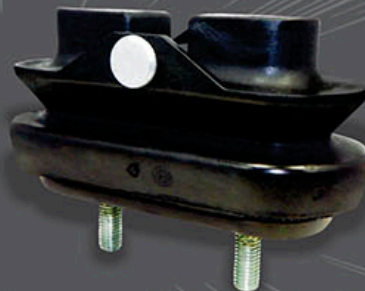

## 8185-H





7506024150798

### SOPORTE PARA MOTOR IZQUIERDO Y DERECHO (CHICO)

MARCA	MODELO		
DODGE	RAM 2500	V8 5.7	03-07
DODGE	RAM 3500	V8 5.7	03-07

OEM 52021713AB



80.01mm



## 8186



7506024150804

### SOPORTE PARA MOTOR DERECHO (TRANSMISIÓN VARIABLE)

MARCA	MODELO		
HONDA	CIVIC	L4 1.8	14-15

OEM 50820-TR0-A61



## 8187



7506024150934

### REPUESTO PARA SOPORTE DE TRANSMISIÓN

MARCA	MODELO		
SUZUKI	KIZASHI	L4 2.4	10-16

OEM N-D



## 8188-9







7506024151658

### SOPORTE PARA MOTOR FRONTAL

MARCA	MODELO		
INFINITI	I30	V6 3.0	97-01
INFINITI	I35	V6 3.5	00-04
NISSAN	MAXIMA	V6 3.0	95-00
NISSAN	MAXIMA	V6 3.5	00-03

OEM 11270-2Y01C



## 8253-EL

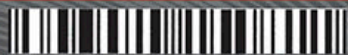

7506024150811

### JUEGO DE BUJES PARA BRAZO TRASERO INFERIOR (MOÑO)

MARCA	MODELO	
MITSUBISHI	OUTLANDER	03-13
MITSUBISHI	LANCER	08-17

OEM N/D



## 64829



7506024150828

### JUEGO DE BUJES PARA HORQUILLAS TRASERAS SUPERIORES

MARCA	MODELO	
MITSUBISHI	OUTLANDER	03-06
MITSUBISHI	LANCER RALLART	02-07

OEM N-D



## 64830





7506024150835

### JUEGO DE BUJES PARA HORQUILLAS TRASERAS INFERIORES

MARCA	MODELO	
MITSUBISHI	OUTLANDER	03-06
MITSUBISHI	LANCER RALLART	02-07

OEM N-D



## 64831



7506024150842

### JUEGO DE BUJES PARA TIRANTES TRASEROS SUPERIORES

MARCA	MODELO	
MITSUBISHI	OUTLANDER	03-06
MITSUBISHI	LANCER RALLART	02-07

OEM N-D



## 64832



7506024150859

### JUEGO DE BUJES PARA HORQUILLAS TRASERAS SUPERIORES

MARCA	MODELO	
DODGE	CALIBER	07-13
JEEP	COMPASS	07-17
JEEP	PATRIOT	07-17

OEM N-D



## 64833





7506024150866

### JUEGO DE BUJES PARA HORQUILLAS TRASERAS INFERIORES

MARCA	MODELO	
DODGE	CALIBER	07-13
JEEP	COMPASS	07-17
JEEP	PATRIOT	07-17

OEM N-D



# 64834



7506024150873

### JUEGO DE BUJES PARA TIRANTES TRASEROS SUPERIORES

MARCA	MODELO	
DODGE	CALIBER	07-13
JEEP	COMPASS	07-17
JEEP	PATRIOT	07-17

OEM N-D



# 64835



7506024150880

### JUEGO DE BUJES PARA HORQUILLAS TRASEROS SUPERIORES

MARCA	MODELO	
MITSUBISHI	OUTLANDER	07-13
MITSUBISHI	LANCER	02-17

OEM N/D



# 64836





7506024150897

### JUEGO DE BUJES PARA HORQUILLAS TRASERAS INFERIORES

MARCA	MODELO	
MITSUBISHI	OUTLANDER	07-13
MITSUBISHI	LANCER	02-17

OEM N/D



## 64837



7506024150903

### JUEGO DE BUJES PARA TIRANTES TRASEROS SUPERIORES

MARCA	MODELO	
MITSUBISHI	OUTLANDER	07-13
MITSUBISHI	LANCER	02-17

OEM N-D



## 64838



7506024150910

### JUEGO DE BUJES PARA PORTA MANGO TRASERO TIPO ROTULA

MARCA	MODELO	
DODGE	JOURNEY	11-19

OEM N-D



## 64839

# MEDIDAS

**7409-9**

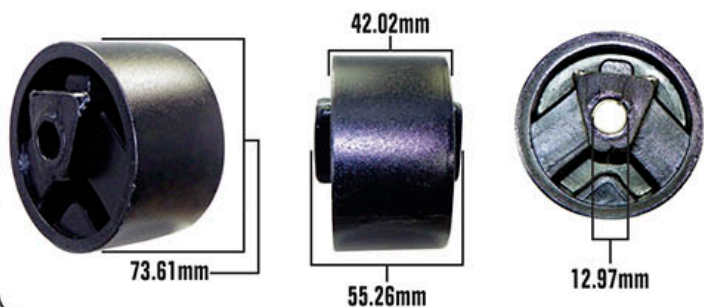

**7546-9**

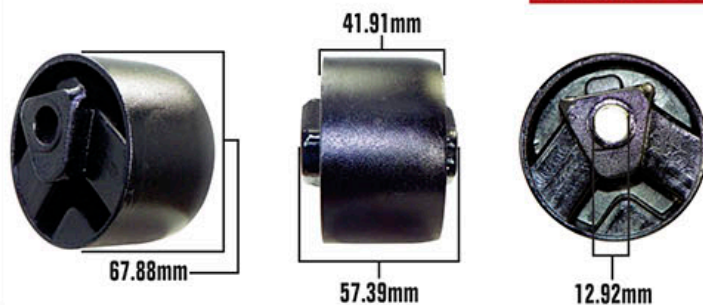

**7822-9**

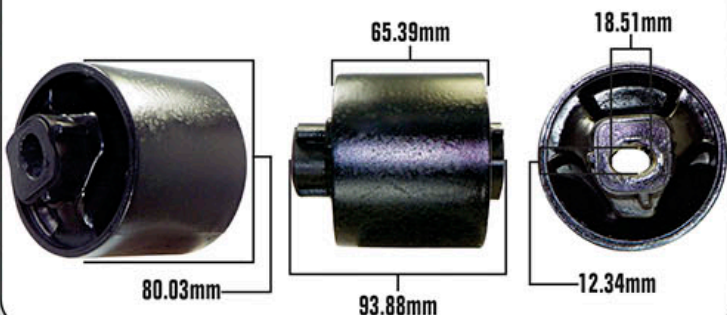

**7938-9**

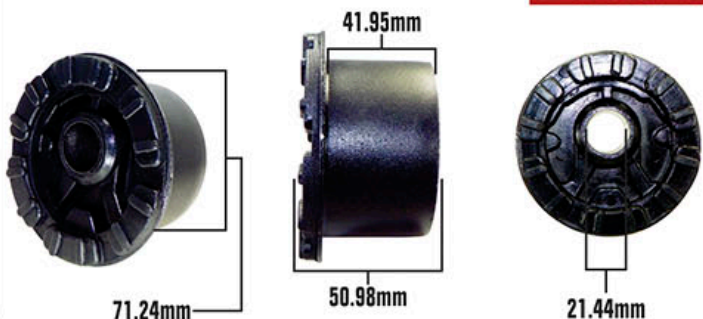

**8188-9**

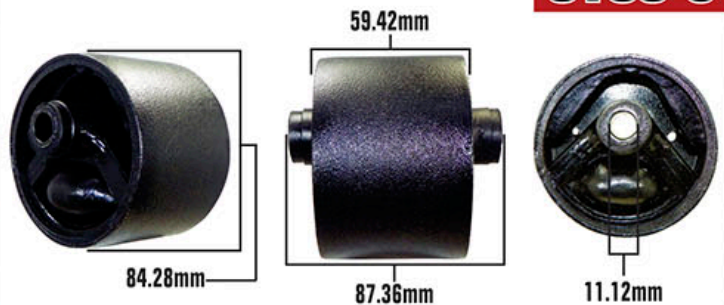

**2 BUJES DEL MISMO TAMAÑO**

**64829**

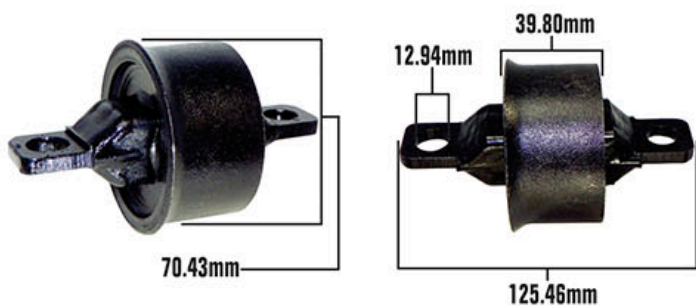

# MEDIDAS

## 1 2 BUJES DEL MISMO TAMAÑO

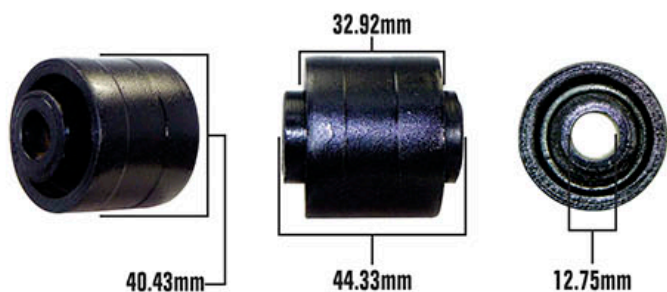

## 2 2 BUJES DEL MISMO TAMAÑO

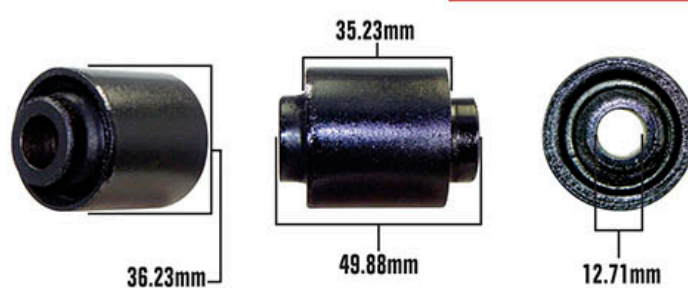

**64830**

## 1 2 BUJES DEL MISMO TAMAÑO

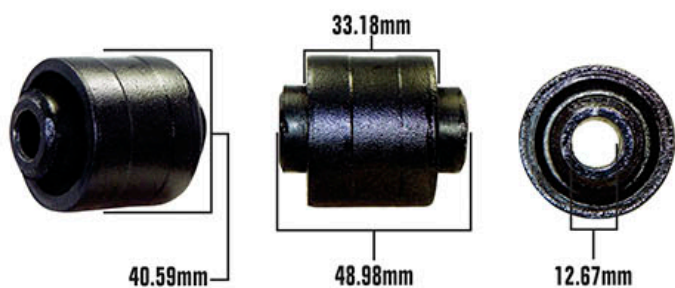

## 2 2 BUJES DEL MISMO TAMAÑO

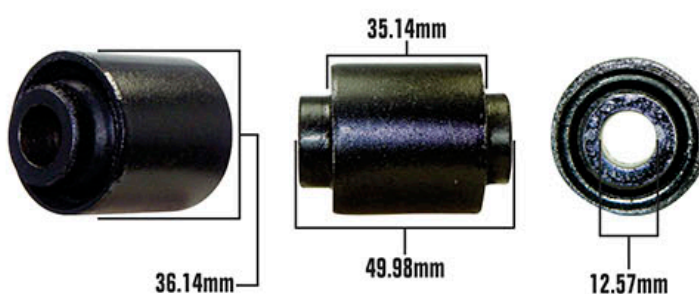

**64831**

## 1 2 BUJES DEL MISMO TAMAÑO

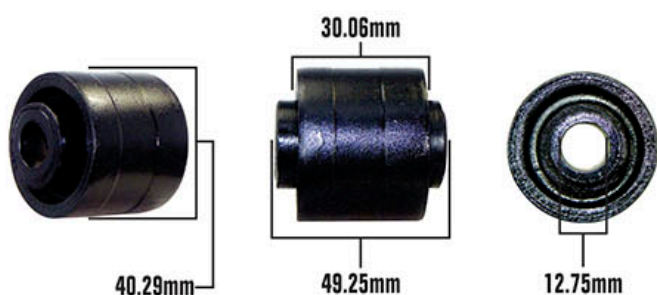

## 2 2 BUJES DEL MISMO TAMAÑO

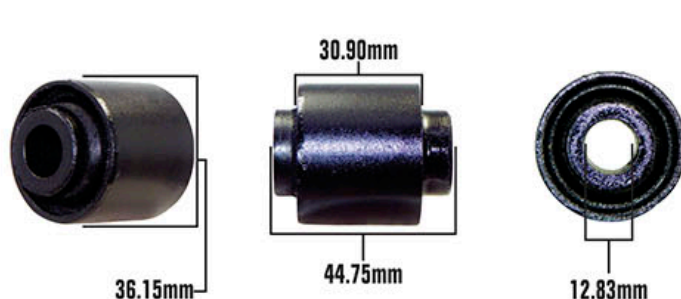

**64832**

# MEDIDAS

### 1 2 BUJES DEL MISMO TAMAÑO

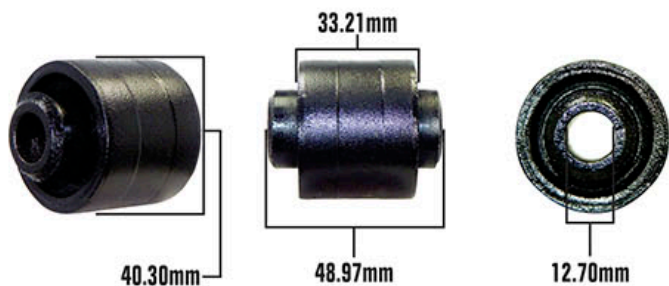

### 2 2 BUJES DEL MISMO TAMAÑO

**64833**

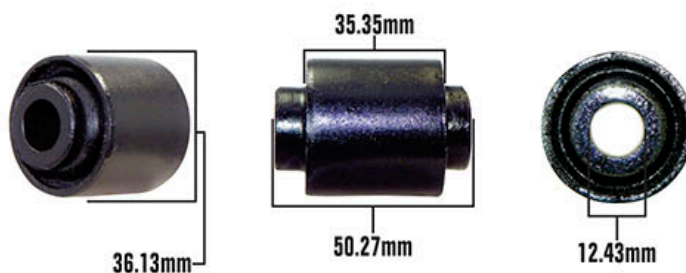

### 1 2 BUJES DEL MISMO TAMAÑO

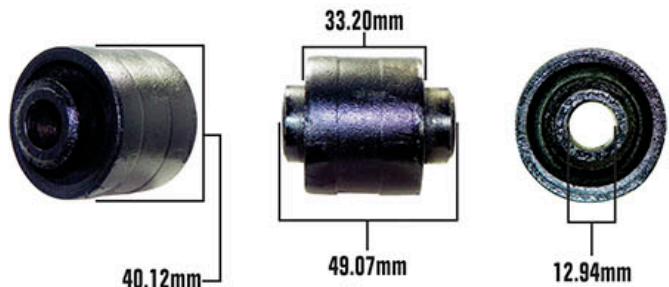

### 2 2 BUJES DEL MISMO TAMAÑO

**64834**

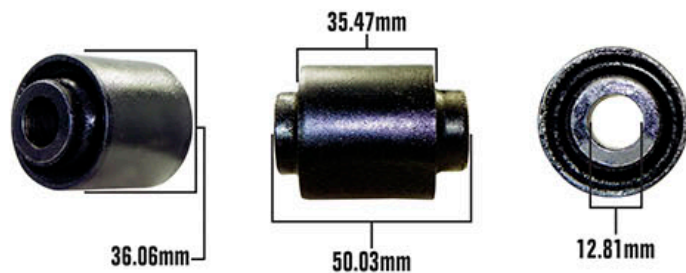

### 1 2 BUJES DEL MISMO TAMAÑO

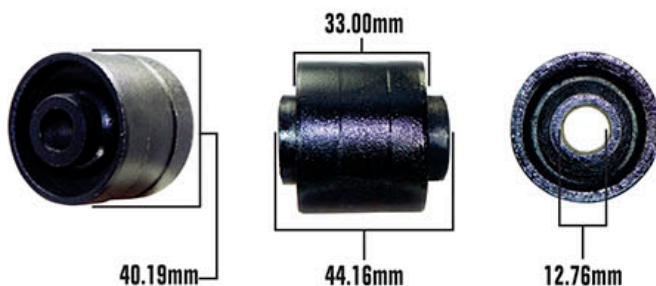

### 2 2 BUJES DEL MISMO TAMAÑO

**64835**

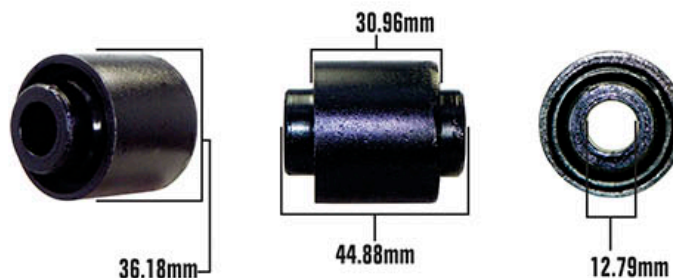

### MEDIDAS

4 BUJES DEL MISMO TAMAÑO

**64836**

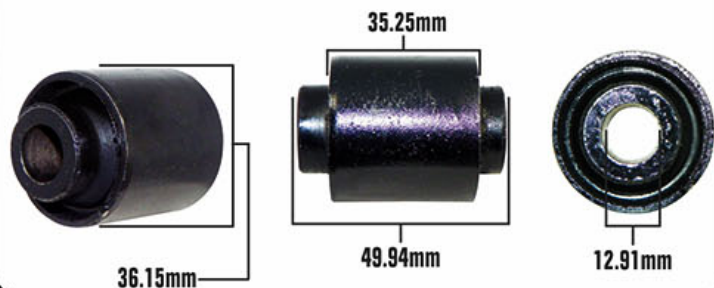

4 BUJES DEL MISMO TAMAÑO

**64837**

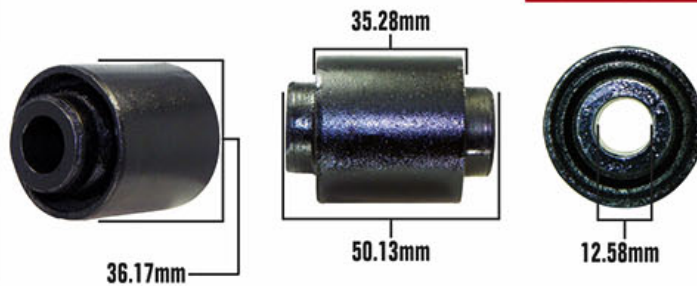

**1**

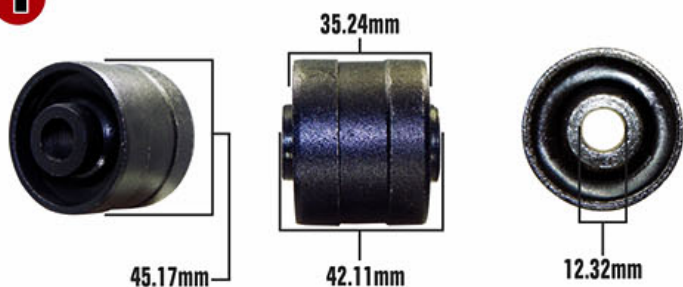

**2**

**64839**

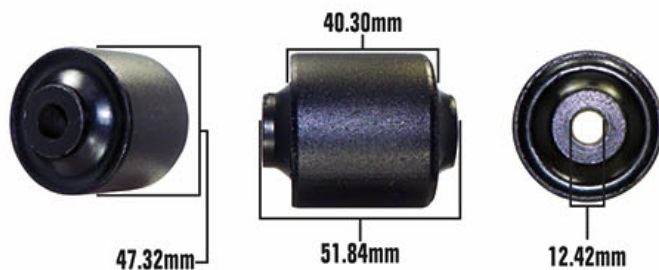

**3**

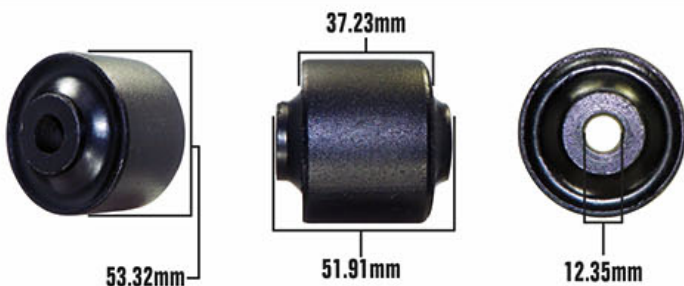

4 BUJES DEL MISMO TAMAÑO

**64838**

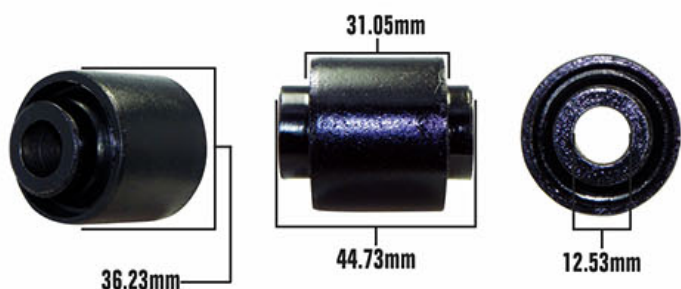

En espera de su apoyo para el buen desplazamiento de este producto quedo de ustedes.

Atentamente

Gerente Comercial